

CR2025

Lithium Button Cell

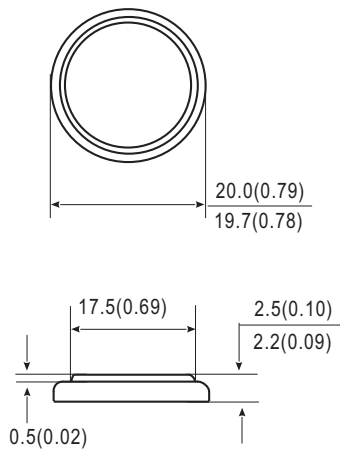

Dimensions



Unit:mm(inch)

Specifications

Chemical System:	Lithium/Manganese Dioxide
IEC Name:	CR 2025
ANSI/NEDA:	5003LC
Camelion Model:	CR2025
Average Weight:	2.7g
Dimension(Ø x H):	20.0 ^{-0.3} x2.5 ^{-0.3} mm 0.79 ^{-0.01} x0.10 ^{-0.01} inch
Terminals:	Flat
Nominal Voltage:	3.0Volts
Capacity:	160mAh (Rated at 15kΩ to 2.00V)
Standard Discharge Current:	0.2mA
Max. Continuous Discharge Current:	0.5mA
Max. Pulse Discharge Current:	15.0mA
Operating Temperature:	-20°C-60°C
Storage Temperature:	18°C-28°C
Relative Humidity:	60±15%
Cross Reference:	E-CR2025(Energizer) DL2025(Duracell) KECR2025(Rayovac)

Usage Guide



Calculator



Remote control



Electronic scales

Cautions

Storage

Store the battery in a cool, dry and well-ventilated area.

Handling

- 1)Never charge the battery. Do not heat or disposed in fire or water. Do not modify or disassemble the battery.Do not short-circuit positive (+) and negative (-) terminals. Keep away from metal or other conductive materials.
- (2)Keep away from infants. If infant happens to swallow the battery, consult a doctor immediately.
- (3)When the battery is stored or disposed, isolate positive (+) and negative (-) terminals of the battery to avoid those terminals touch each other.
- (4)In case the battery electrolyte happen to come into mouth,gargle well enough and consult a doctor immediately.

Notice:

Environmental elements comply with RoHS requirements.This information is subject to change without prior notice and for reference only. It should not be used as a basis for a product guarantee or warranty . For additional information, please consult your nearest Camelion Sales Office or Distributor or visit our website at: www.camelionbattery.com.

CR2025

Lithium Button Cell

Discharge Characteristics

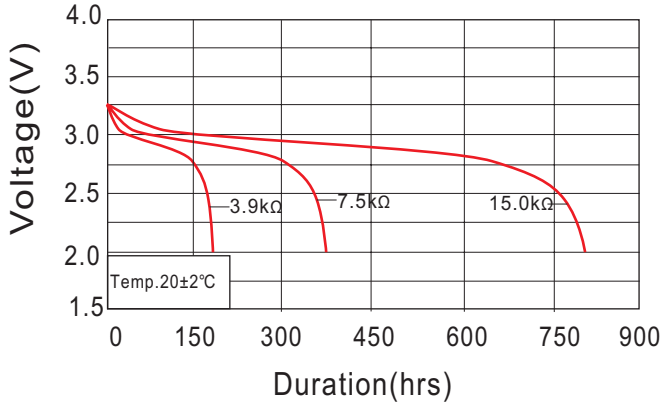

Temperature Characteristics

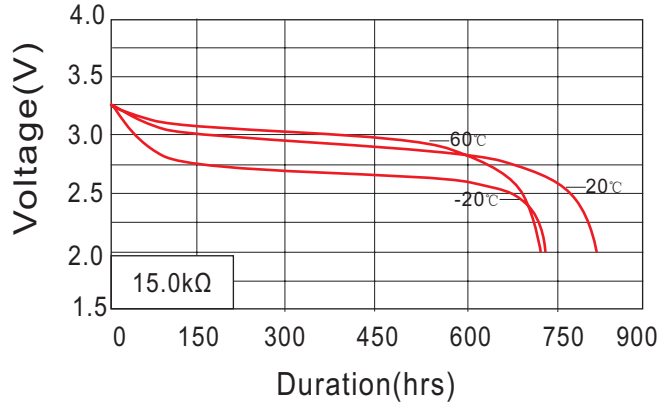

Load-capacity Characteristic

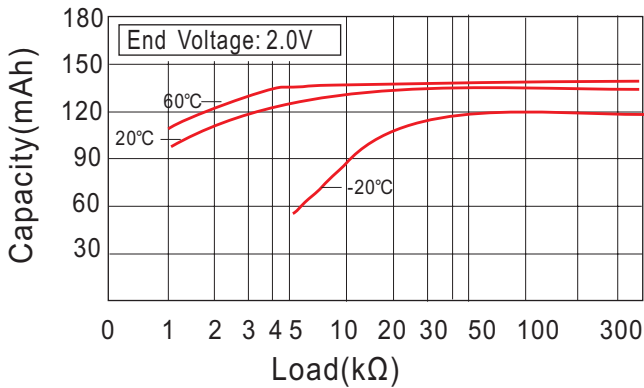

Operating Voltage

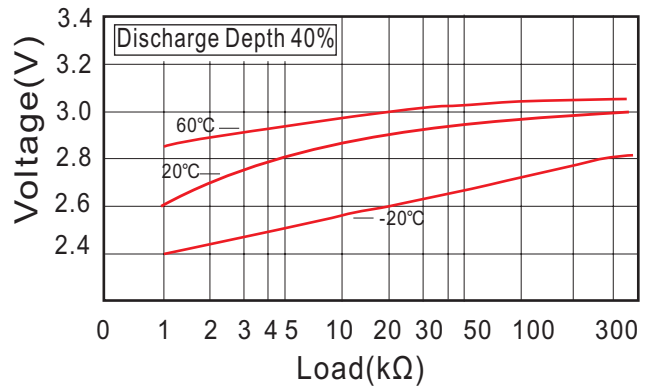

Pulse Discharge Characteristic

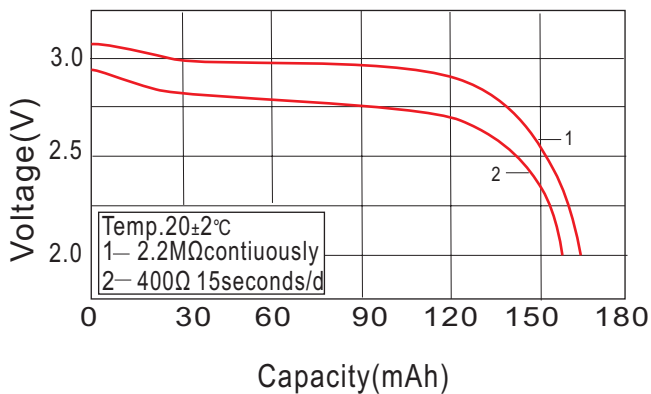

Storage Characteristic

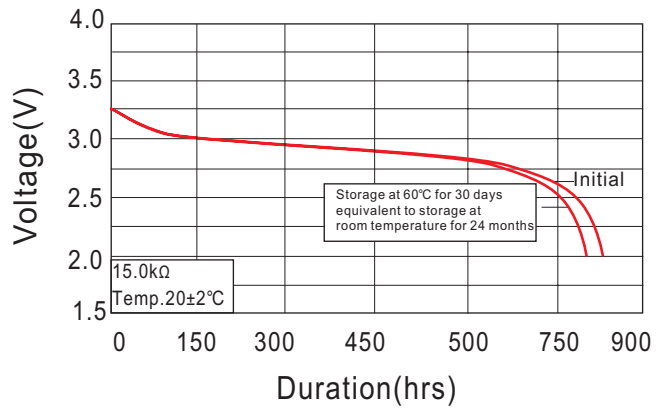

Notice:

Environmental elements comply with RoHS requirements. This information is subject to change without prior notice and for reference only. It should not be used as a basis for a product guarantee or warranty. For additional information, please consult your nearest Camelion Sales Office or Distributor or visit our website at: www.camelionbattery.com.